

1. Setting up your equipment:

Home Use:

- Fill bag and hang on IV Pole. (*Picture 1*)
- Attach tubing to pump. (*Picture 2*)
- Pump should be set to OFF before plugging into electrical outlet.
- Plug Input 120 V, 60Hz, 200 mA

Ambulatory:

- Check for battery charge.
- Fill bag. (*Picture 3*)
- Attach to pump.
- Place into ambulatory bag.

Picture 1



Picture 2



Picture 3

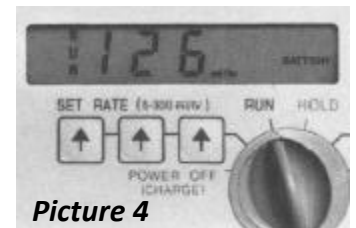


2. Using your equipment:

- Turn pump dial to the Set Rate position, and set designated food rate (mL/hr). (*Picture 4*)
- Locate correct dose and set to instructions.
- Press/Turn/Set to run

*If product is not filled at bedside, it is advisable to close slide clamp before transporting.

*Make sure slide clamp is open for set up.



Picture 4

3. Frequent replacement items:

Tubing (*Picture 5*)



Feeding bags (*Picture 6*)



4. Special Procedures:

- Ambulatory Pump:

- Must have correct ambulatory bag for pump and tubing bags to work properly. Brands may differ. Check instructions for placement of pump and bag.

- A new pump should be plugged into an A/C outlet before initial use for directed amount of time to assure full battery charge.

5. Safety Issues:

- Alarm Sounding:
 - Check for kink(s) in the tubing.
 - Check for empty bag (do not operate pump with empty bag)
 - Check for low battery
 - Check for clogging in the line, slide the clamp to assure its completely open.
 - Check drip chamber to be sure its not more than 1/4 full or coated with product.
 - Be sure all bags and tubing are compatible with the pump you are using.

6. Maintenance:

- The outside of the pump can be cleaned with warm soapy water.
- The pump cavity can be cleaned with a cotton swab or soft cloth and warm soapy water. DO NOT CLEAN WITH ALCOHOL.
- Pump should be turned off or recharge battery (if available) when not in use.
- DO NOT SUBMERGE OR AUTOCLAVE the pump or charger.

*** Please contact your local CareLinc provider for any questions, adjustments, or repairs. ***



Enteral formulas are liquid food products that are specially formulated and designed to increase the amount of various food elements and nutrients that will maintain proper physiological function of the body process. They may also be used to correct an existing deficiency.

Proper Use of Enteral Nutrition Formula: Your enteral feeding may be given by mouth or by a feeding tube. Use the amount recommended by your doctor.

For patients taking the **oral liquid** form of enteral nutrition:

- This preparation is in ready-to-use form. No dilution is needed unless directed by your physician.
- Shake the preparation well before opening. Refrigerate after opening, out of the reach of children. Most formulas can be kept in the refrigerator for 1 to 2 days. Check the label of your product.

For patients using the **powder** form of this preparation:

- For mixing or other use, follow carefully the instructions on the package.
- Any unused solution should be kept in the refrigerator, out of the reach of children. Most formulas can be kept in the refrigerator for 1 to 2 days. Check the label of your product.

Storage

To store the unopened container:

Keep out of the reach of children.

Store away from heat and direct light.

Do not store in the bathroom, near the kitchen sink, or in other damp places. Heat or moisture may cause the enteral nutrition formula to break down.

Keep the enteral nutrition formula from freezing. Do not refrigerate, unless the product has been opened or mixed.

Do not keep outdated enteral nutrition formulas or those no longer needed. Be sure that any discarded enteral nutrition formula is out of the reach of children.

Never tamper with the label on enteral nutritional formula.

Always refer to the label for usage, safety and storage information.



CareLinc Medical Equipment
www.carelinccmed.com
888.810.5462

BENEFICIARY NAME: _____

DATE: _____

ADDRESS: _____

ITEM: ENTERAL FOOD PUMP

Medicare requires your supplier to give you the option of purchasing the enteral food pump that you are being setup with today. This means, if you accept the purchase option, Medicare will be billed for the full purchase price of the enteral pump. You will be responsible for the 20% coinsurance and any remaining deductible with Medicare.

Should you decide to not elect the purchase option, Medicare will make 15 monthly rental payments. You will be responsible for the 20% coinsurance each month as well as any remaining deductible with Medicare.

In making your decision to rent or purchase the equipment, your supplier may charge you coinsurance as well as any remaining deductible with Medicare each time that your equipment is actually serviced after the 15 rental months.

Please indicate your choice today in the area below. If you have any questions, please feel free to call us at the number listed at the top of this letter.

Options:

Continued Rental

Purchase

BENEFICIARY SIGNATURE: _____

DATE: _____

ACCT. # _____

**AFTER COMPLETION, PLEASE GIVE COPY TO CUSTOMER AND KEEP ORIGINAL COPY WITH SETUP PACKET*

tyco / Healthcare

KENDALL

CARELINC
Home Medical Equipment & Supply

www.carelincmed.com

888.810.5462

KANGAROO ePump™

Enteral Feeding Pump

Operation and Service Manual

Enteral Feeding Pump — Operation and Service Manual

Nutripompe — Manuel d'utilisation et d'entretien

Pumpe für die enterale Ernährung — Betriebs- und Serviceanleitung

Pompa di alimentazione enterale — Manuale operativo e di manutenzione

Bomba para alimentación enteral — Manual de operación y servicio

Enteral matningspump — Användar- och servicemanual

Enterale voedingspomp — Handleiding voor bediening en onderhoud

Bomba de alimentação entérica — Manual de funcionamento e assistência

Enteriaalinen ravitsemuspumppu — Käyttö- ja huolto-opas

Pumpe til enteral ernæring — Betjenings- og servicehåndbog

Αντλία εντερικής σίτισης — Εγχειρίδιο λειτουργίας και σέρβις

Pumpa pro enterální výživu — Provozní a servisní příručka

Enterális táplálópumpa — Kezelési és karbantartási kézikönyv

Насос для энтерального питания — Руководство по эксплуатации и техническому обслуживанию

Pompa żywienia dojelitowego — Instrukcja obsługi i serwisowania

Enteral Besleme Pompası — Operasyon ve Servis Kılavuzu

Enteral ernæringspumpe — Bruker- og vedlikeholdshåndbok

AccuSystem™



Rx
ONLY



0123

See Instructions

™ Trademark of Tyco Healthcare Group LP or its affiliate.

™SPRAY-NINE is a trademark of Spray-Nine Corporation.

™PHISOPHEX is a trademark of Smith Kline Beecham Corp.

™HIBICLENS is a trademark of Tubifoam Ltd.

™VESTA-SYDE is a trademark of Steris, Inc.

TYCO HEALTHCARE GROUP LP • MANSFIELD, MA 02048

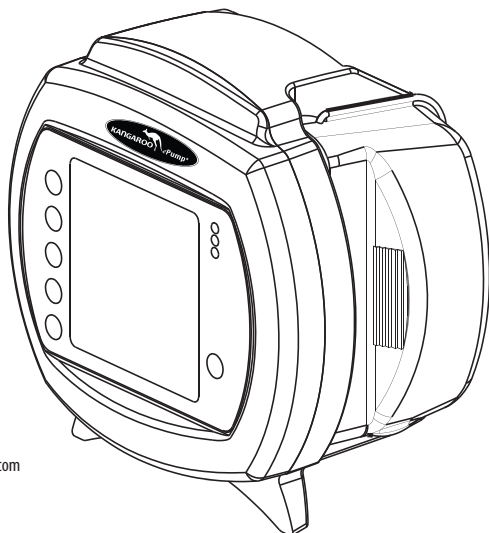
MADE IN U.S.A. • © 2005 TYCO HEALTHCARE GROUP LP

ALL RIGHTS RESERVED • 050328

PRODUCT INFORMATION IN U.S. 1-800-962-9888 • www.TycoHealthcare.com

EC REP: TYCO HEALTHCARE U.K. LTD • GOSPORT, PO13 0AS, U.K.

SWISS DISTRIBUTOR: TYCO HEALTHCARE SWITZERLAND LTD.
ROOSTRASSE 53, POSTFACH CH-8832, WOLLERAU SWITZERLAND



Thank you for purchasing the **KANGAROO ePump™** Enteral Feeding Pump.
With proper care, this device will provide you with years of precision service.

TABLE OF CONTENTS

	Page
Section I — General Information	5
Section II — Safety and Warnings	7
Section III — Icon Identification	8
Section IV — Initial Setup	
Attaching the A/C Adapter Power Cord	9
Battery Setup	9
Attaching Pole Clamp	10
Section V — Instructions for Use	
Quick Start	11
General Startup	12
<i>Placement/Mounting</i>	12
<i>A/C Power Operation</i>	12
<i>Battery Power Operation</i>	12
<i>Power On/Off</i>	12
<i>Language Selection, First Power Up</i>	12
<i>Keep or Clear Prior Pump Settings</i>	12
Loading Pump Sets	13
Prime Pump	14
<i>Auto Priming</i>	15
<i>Hold-To-Prime</i>	15
<i>Re-priming after Bag Empty</i>	15
Selecting Continuous or Intermittent Feed Mode	16

TABLE OF CONTENTS

	Page
Continuous Mode (Adjust Feed).....	16
<i>Continuous Mode Feeding</i>	16
<i>Continuous Mode Flushing</i>	17
Intermittent Mode (Adjust Bolus).....	18
<i>Intermittent Mode Feeding</i>	18
<i>Intermittent Mode Feeding – Bolus Max</i>	19
<i>Intermittent Mode Flushing</i>	19
<i>Run</i>	20
<i>Hold</i>	21
<i>Flush Now</i>	22
More Options.....	23
<i>Buzzer Alarm Volume</i>	23
<i>History</i>	23
<i>Language Selection</i>	23
<i>Continuous/Intermittent Mode</i>	23
BioTech Menu	24
<i>Accessing the BioTech Screen</i>	24
<i>BioTech Screen Data</i>	24
<i>Lock Settings Feature (Program Locked)</i>	24
Lock Screen Feature.....	25
Section VI — Re-Certification of Performance	
System Performance Re-Certification.....	25
Certifying the Accuracy of Pump Flow Rate	26
Section VII — Cleaning	26
Section VIII — Battery Replacement	28

TABLE OF CONTENTS

	Page
Section IX — Error/Warning/Informational Screens and Troubleshooting	
System Error	29
Hold Error	30
Rotor Error.....	31
Feed Error	31
Flush Error	31
Flow Error	32
Pump Set Dislodged Error.....	32
Battery Low	33
Feeding Complete	33
Pump Set Use >24 Hours Warning	33
LED Array.....	34
Section X — Specifications and Symbols	
Specifications	34
Symbols on Pump and Accessories	36
Section XI — Customer Service	37
Section XII — Maintenance	
Side Door Enclosing Pump Set Loading Area	37
Battery Pack	38
Battery Door.....	38
Power Cord	38
Pole Clamp	38
Section XIII — Service Part Numbers	38
Section XIV — Warranty	38
Section XV — Electromagnetic Conformity Declaration	39
Section XVI — AccuSystem[√]	40

Section I – General Information

The KANGAROO ePump enteral feeding pump is a simple-to-use, precision enteral feeding pump. It is easily programmed to provide patients with either continuous or intermittent feeding, and can provide automatic flushing capability when used with KANGAROO ePump Feed & Flush Sets.

User Interface:

- Intuitive user interface
- Large, backlit LCD display
- Step-by-step prompts to guide programming and operation
- “Stoplight” LED array visually indicates pump status in a bright or darkened room

Ergonomics:

- Quiet operation
- Compact, aesthetic design
- Tabletop usage or IV pole mounting
- Simple loading of Pump Sets
- Transparent side door to protect Pump Set
- Integrated handle for easy transport

Features:

- MISTIC (Magnetic Intelligent Set Type Identification Connector) Feed-Only vs. Feed & Flush Set identification system to ensure match between the pump’s user interface and Pump Set type
- Automatic Anti-Free-Flow (AFF) System
- Audible alarm to indicate errors or Pump Set loading conditions
- Attitude-independent design eliminates need for drip chamber on pump set
- Sensor technology detects both upstream and downstream flow conditions
- Continuous feed, intermittent feed, and flush capability
- Auto-prime feature reduces the need for time-consuming manual priming
- Hold feature with programmable restart
- Stores previous 72 hours of feeding and flushing history

Service:

- Serial I/O port for data retrieval and software updates
- Uses replaceable, rechargeable NiMH Battery Pack for 15 hours of backup power
- Removable Power Cord
- Removable Pole Clamp

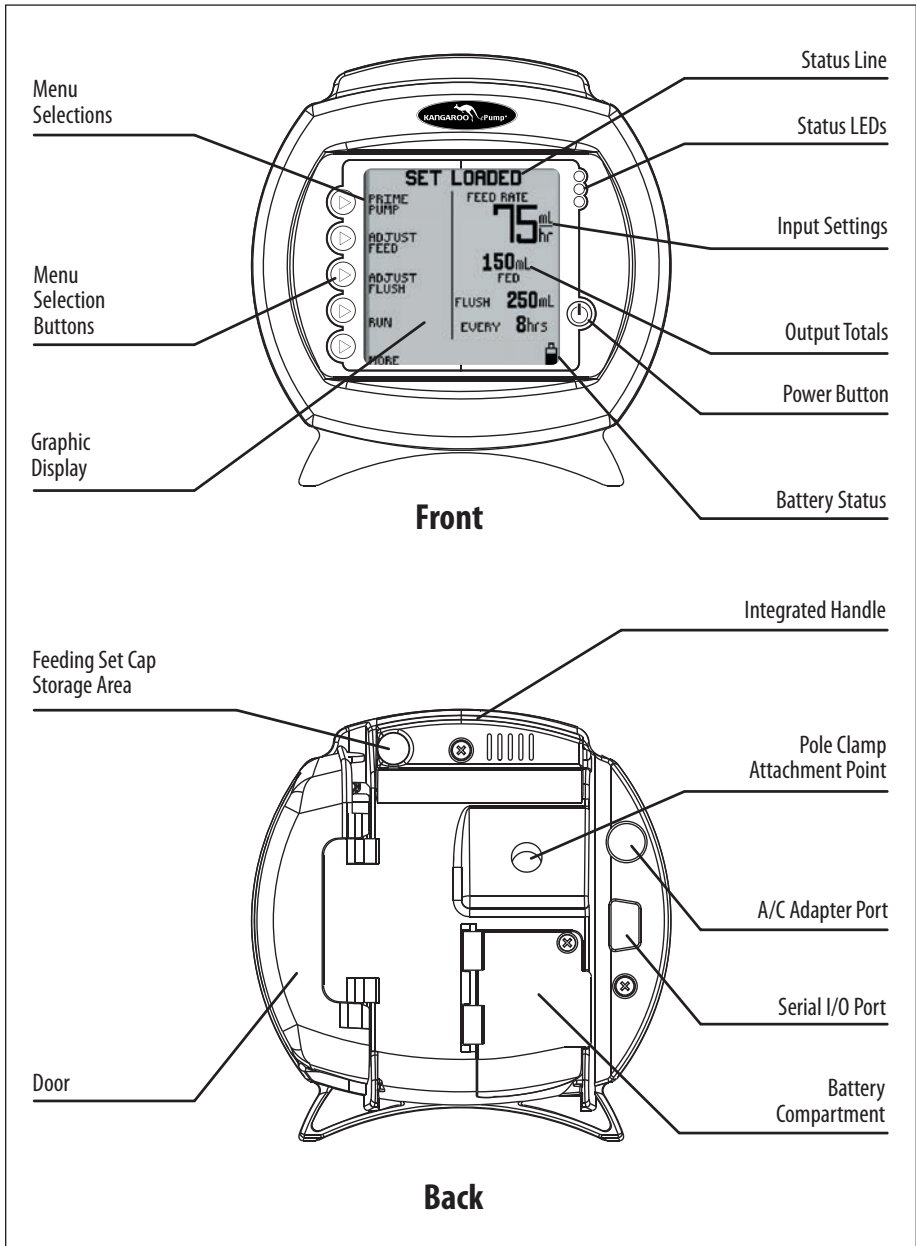


Figure 1A. KANGAROO ePump features, front and rear views.

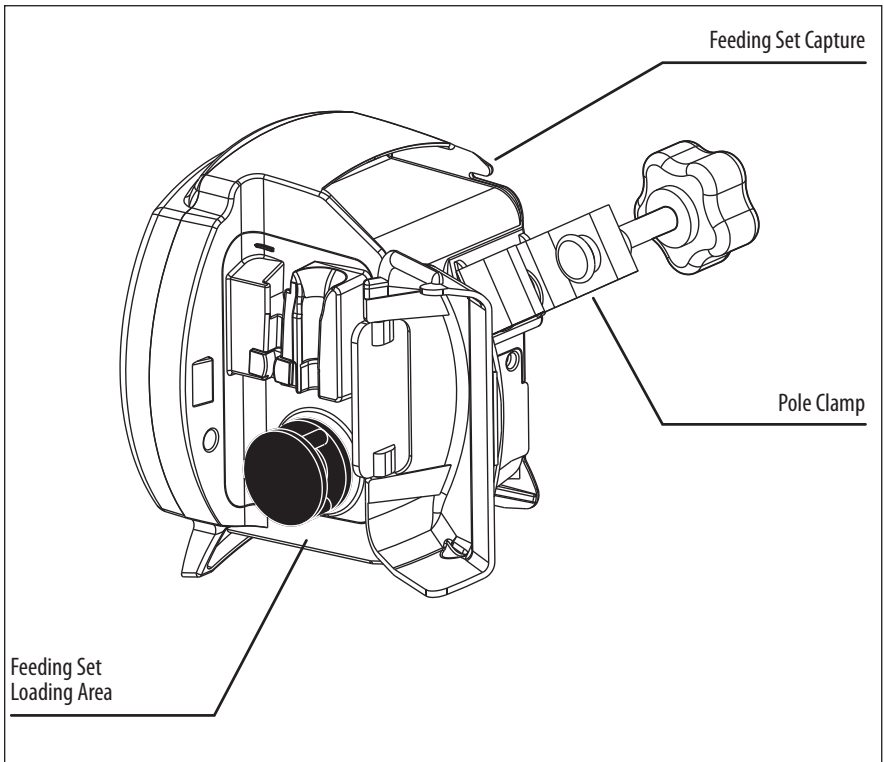


Figure 1B. KANGAROO ePump Pump Set loading area.

Section II — Safety and Warnings

CAUTION: U.S. federal law restricts the sale of this device to physicians or to their direct representatives.

1. Read this booklet thoroughly before using the KANGAROO ePump enteral feeding pump.
2. Do not use this device near flammable anesthetics.
3. Disconnect power supply before cleaning or servicing.
4. Use only KANGAROO ePump enteral feeding pump Power Cord (with built-in A/C adapter) with pump. See Section XIII - Service Part Numbers for replacement of Power Cord.
5. Use only KANGAROO ePump enteral feeding pump Pump Sets with this device. Pump is not compatible with other Pump Sets.
6. For re-certification, see Section VI - Re-certification of Performance. For other integrity checks, consult with a qualified Biomedical technician or contact the manufacturer (Section XI - Customer Service).
7. For service or for technical information, please contact Customer Service (Section XI).
8. Do not open the main housing, as there are no user-serviceable parts inside. Opening may affect function of device and voids the warranty. To replace battery, see Section VIII.
9. Dispose of old battery-powered electronic equipment in a manner consistent with institutional policy for expired equipment disposal.
10. Cleaning frequency and practices must be consistent with institutional policy for cleaning of non-sterile devices. See Section VII - Cleaning, for instructions on cleaning the KANGAROO ePump enteral feeding pump.

English

11. See icon descriptions in Section III-Icon Identification and Section X - Specifications and Symbols for additional safety information.
12. This device is designed to minimize the effects of uncontrolled electromagnetic interference and other types of interference from external sources. Avoid use of other equipment that may cause erratic operation or degradation in the performance of this device.
13. **WARNING:** The DB9 serial I/O port (see Figure 1A) is intended only for use by the manufacturer.
Any accessory equipment that can be connected to the DB9 Serial I/O port, and which does not comply with the equivalent safety requirements of this equipment, may lead to a reduced level of safety of the pump. While use of the pump's DB9 port is not recommended for customers, the following should be considered in the event that the customer decides to connect to this port:
 - The accessory is specifically certified as complying with the safety requirements for accessories used with the pump, whereas the safety certification of the accessory has been performed in accordance to the appropriate IEC 60601-1 and/or IEC 60601-1-1 harmonized national standard.
 - Under no circumstances should the certified accessory be used while the pump is in use for enteral feeding of a patient.
14. **CAUTION:** This enteral feeding pump should only be used for patients who can tolerate the flow rates and accuracy levels delivered by the pump. Premature infants may require higher accuracy rates than specified for this enteral feeding pump.

Section III – Icon Identification

Run Mode

Vertically-moving droplet in **RUNNING** screen indicates Run mode.



Battery Symbols

- Full charge
- 2/3 or less charge
- 1/3 or less charge
- Very low battery (15 minutes max.)



Auto Priming Indicator

When auto priming, the bar will progress to show auto prime feature is active.



Volume Setting

Indicates alarm volume setting.



Error Indicator

Pump operations are stopped until the error is resolved.

**Information Indicator**

This indicates information only, and does not require any immediate action.



Section IV — Initial Setup

Attaching the A/C Adapter Power Cord

Plug the Power Cord into the A/C Adapter Port on the back of the pump. See Figure 1A to locate port on pump. Make note of the location of the pins and tab on the plug to properly orient the plug.

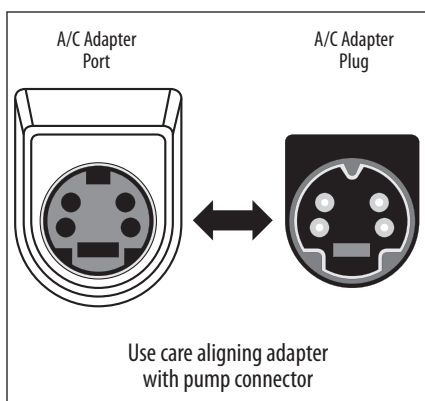


Figure 2. Alignment of A/C Adapter plug with pump's adapter port.

The connector, which attaches to the back of the pump, has a spring-loaded locking sleeve that locks into the pump, thus helping to prevent the connector from being accidentally knocked out. To remove the connector, grasp the outer sliding sleeve member and pull. Do not detach the connector by pulling on the cord only.

Battery Setup

The battery pack is fully charged before shipping, and is left unconnected to optimally preserve battery life.

WARNING: The battery should be connected before using the pump.

It is also recommended that the battery charge be “topped off” before battery-only operation is utilized. The battery pack will charge continuously whenever the pump is plugged into a wall outlet, including during normal use of the pump with A/C power. Eight hours of charging is required to fully recharge the battery pack.

A new battery pack will provide approximately 15 hours of service before needing to be recharged.

English**Attaching Pole Clamp**

The KANGAROO ePump enteral feeding pump can be attached to a vertical pole using the Pole Clamp, included with the pump.

To attach the Pole Clamp to the KANGAROO ePump enteral feeding pump, align the hole on the Pole Clamp with the mounting hole on the back of the pump. Use a 3/8" - 16 bolt to fasten together, as shown in Figure 3.

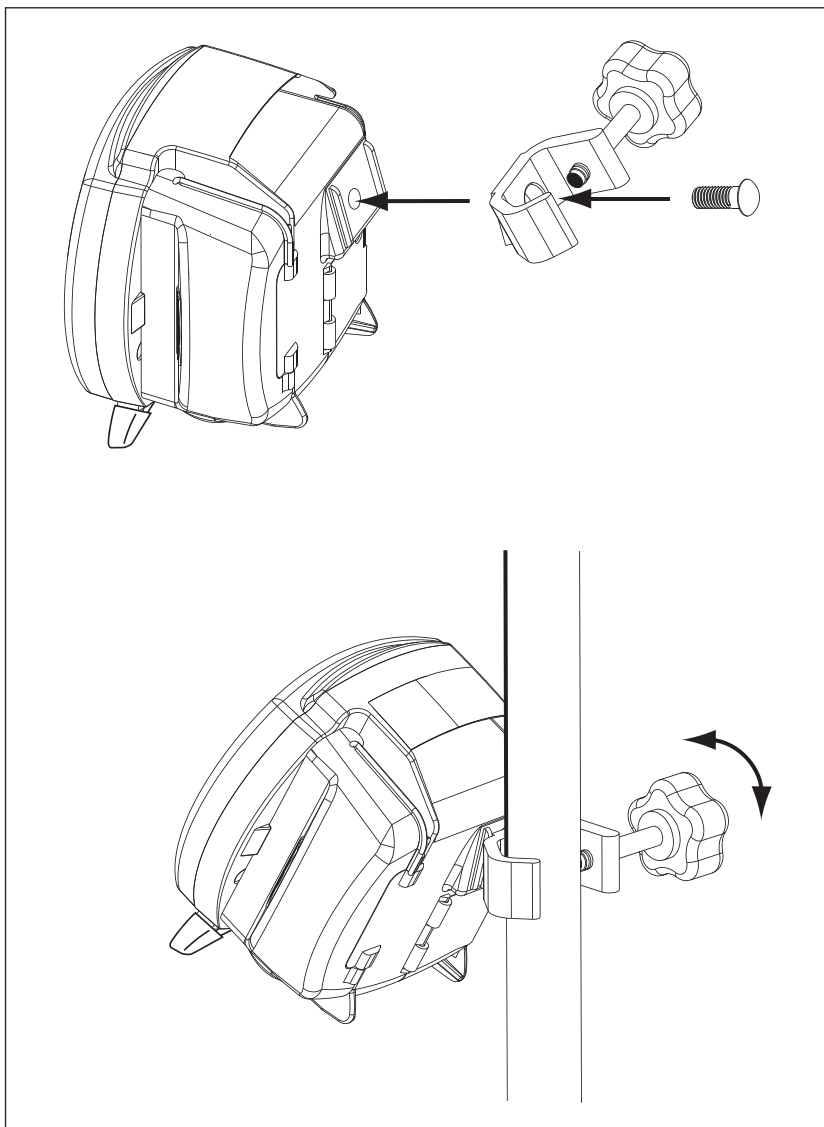


Figure 3. Attaching and using the Pole Clamp.

Section V — Instructions For Use

Quick Start

1. Press **POWER** on lower, right-hand corner of control panel.
2. Open blue door enclosing Pump Set loading area.
3. To load Pump Set (refer to Figure 4):
 - Grasp finger tab on valve and insert into left pocket (1).
 - Grasp black ring retainer and gently stretch tubing around rotor (2). Pull up on retainer and insert into right pocket (3).
 - Press down on finger tab to ensure that valve is fully seated.
 - Close blue door.

(**Note:** display status line should read **SET LOADED**).
4. To automatically prime the pump, press **PRIME PUMP** and **AUTO PRIME**. For Feed & Flush sets, auto priming will prime both lines.
5. To directly control pump priming, press **PRIME PUMP** and then press and hold the **HOLD TO PRIME** button(s). If a Feed & Flush Set is used, remember to first press **HOLD TO PRIME FLUSH** until the flushing fluid has reached the valve, and then press **HOLD TO PRIME FEED** until the feeding fluid has reached past the valve and down to the distal end connector.
6. Use buttons on left side of LCD to set the feeding parameters. Set flushing parameters if a Feed & Flush Set is loaded. The continuous or intermittent feed mode selection is made under the **MORE** options menu.
7. Press **RUN** when ready to start. The screen will display **RUNNING**.
8. To stop, press **HOLD** or press and hold the **POWER** button.

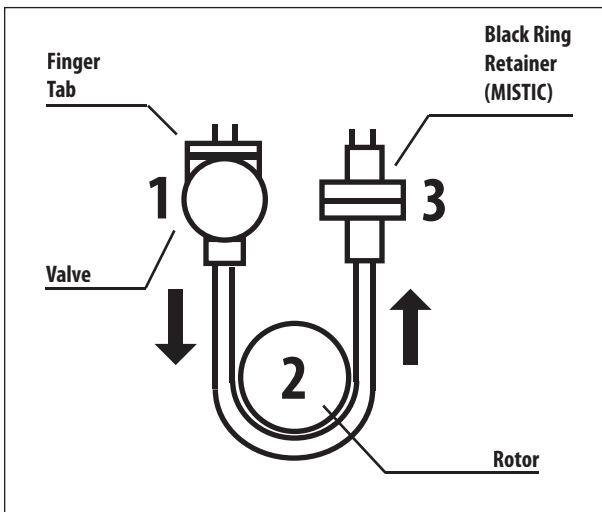


Figure 4.
Installation of
Pump Set.

English

General Startup

Placement/Mounting

There are two recommended placement methods for the KANGAROO ePump enteral feeding pump.

- Attached to a vertical IV pole via the Pole Clamp peripheral device, included with the pump.
- Placed feet down on any horizontal surface.

A/C Power Operation

Plug the KANGAROO ePump enteral feeding pump into an A/C power outlet for normal operation. When the pump is not plugged in, or if A/C power is interrupted, a built-in rechargeable battery will run the pump.

Battery Power Operation




If A/C power is not available to the pump, or if A/C power is interrupted, the pump will automatically operate on backup battery power. The built-in battery recharges any time the pump is plugged into an outlet.

A fully-charged, new battery will supply 15 hours of backup power at 125 ml/hr before requiring recharging. Contact Customer Service, Section XI, to replace the Battery Pack if battery life degrades.

Power On/Off

To power up the pump, press the  **POWER** button on the lower right of the front panel. To power down the pump, press and hold the  **POWER** button until the pump display turns off.

Language Selection, First Power Up

Immediately after powering up the pump for the first time, the language option screen will appear. Select the language using the () or () buttons. When the language is selected, push the fifth button () to enter the language selection. After the language is selected the first time the pump is powered up, the language selection screen will not appear during future power up operations. Should the language need to be changed after the initial power up, it can be changed through the "**MORE OPTIONS**" menu (see Figure 16).

Keep or Clear Prior Pump Settings

Immediately after powering up the pump, if the prior feed or flush settings were not cleared and the settings are not locked in the BioTech Screen, the pump will give the following two options:

KEEP SETTINGS – Select this option to start with the same settings that were most recently programmed into the pump. Any of the previously-programmed settings can be modified, if needed. The feed volume totals, "**mL FED**" (Continuous Feed Mode) or "**BOLUSES FED**" (Intermittent Feed Mode) and "**mL FLUSH**" are also maintained.

CLEAR SETTINGS – Select this option to reset all input feeding settings and the output feed totals to zero. It will then be necessary to program all settings before running the pump.

Note: The output feed totals ("**mL FED**," "**BOLUSES FED**," "**mL FLUSH**") can be cleared at any time, and without clearing the input settings, by doing the following:

- Start the pump **RUNNING**
- Press ► **HOLD**
- Press ► **CLEAR VOLUME**

The status line of the pump will then show **LOAD A SET** (Figure 5), or, if the Pump Set is already loaded, it will show **SET LOADED** (Figure 7).

Loading Pump Sets

The KANGAROO ePump enteral feeding pump will indicate **LOAD A SET** in the screen's status line if a Pump Set is not installed. A blinking icon of a Pump Set will also appear in the upper left corner of the screen. Figure 5A shows the screen for continuous feeding mode and Figure 5B shows the screen for intermittent feeding mode.

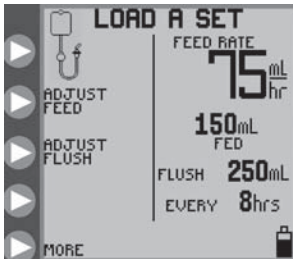


Figure 5A. LOAD A SET opening menu screen for Continuous Feeding mode.

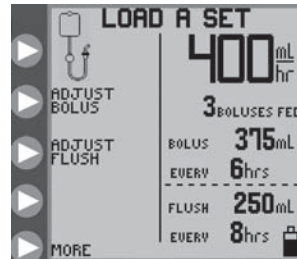


Figure 5B. LOAD A SET opening menu screen for Intermittent Feeding mode.

To load a Pump Set, follow the steps below:

1. Open the blue transparent door that encloses the rotor and Pump Set loading area.
2. Load the Pump Set by holding the finger tab on the valve, and inserting the valve down into the slot on the left. (Figure 6A)
3. Grasp the MISTIC retainer end (black ring retainer) and wrap the tubing counterclockwise around the rotor. (Figure 6B)
4. Carefully pull the MISTIC retainer end upwards to position it over the slot on the right, and then lower the retainer into the slot. (Figure 6B)
5. Press down on the valve's finger tab to ensure proper seating.
6. Close blue transparent door.

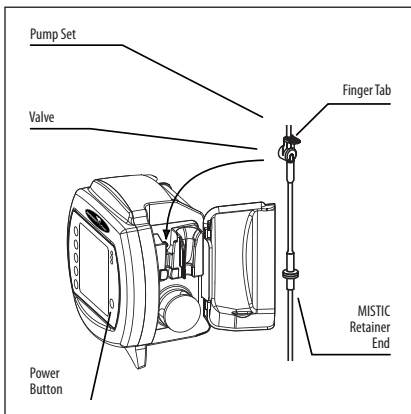


Figure 6A.

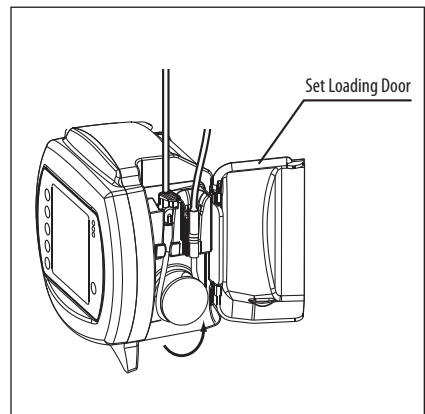


Figure 6B.

English

The display should read **SET LOADED** and will show one of the following opening menus, depending on the type of Pump Set detected, and whether continuous or intermittent feeding mode has been selected.

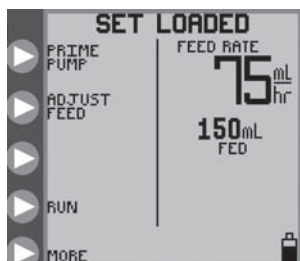


Figure 7A. Opening menu for Continuous Feed mode with a Feed-Only set.

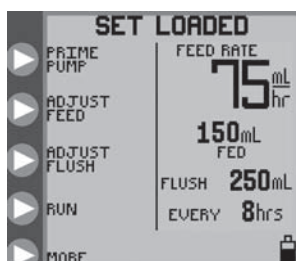


Figure 7B. Opening menu for Continuous Feed mode with a Feed & Flush set.

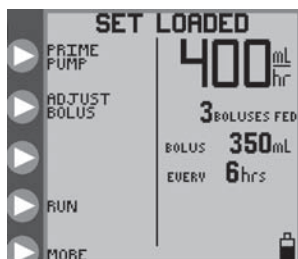


Figure 7C. Opening menu for Intermittent Feed mode with a Feed-Only set.

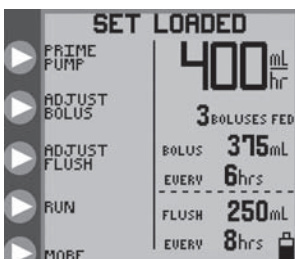


Figure 7D. Opening menu for Intermittent Feed mode with a Feed & Flush set.

Prime Pump

The KANGAROO ePump enteral feeding pump may be primed automatically with a single button push, including the flushing line if a Feed & Flush Set is loaded. The pump can also be primed in a more interactive method using the hold-to-prime feature.

After a Pump Set has been loaded and the status line shows **SET LOADED**, press ► **PRIME PUMP** in the opening menu (Figure 7) to get one of the **PRIME PUMP** menus shown in Figure 8.

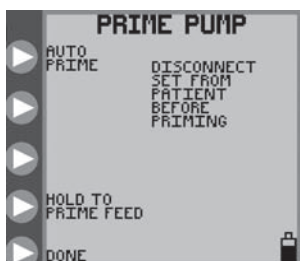


Figure 8A. PRIME PUMP menu for Feed-Only set.

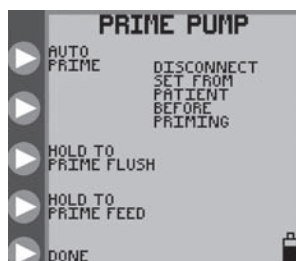


Figure 8B. PRIME PUMP menu for Feed & Flush set.

Auto Priming

The **AUTO PRIME** option will be available if the pump senses that the currently installed Pump Set was not previously primed, and that there is no fluid in the line near the rotor. If auto-priming is desired, press and release ► **AUTO PRIME** to automatically prime the line(s). For Feed & Flush Pump Sets, the auto prime feature will automatically prime both lines, starting with the flush line.

Press ► **STOP** to cancel **AUTO PRIME**.

When auto-priming is completed, the status line will show **AUTO PRIME COMPLETE** and will no longer show the **AUTO PRIME** option. Be sure that the line(s) are fully primed. If not, use the hold-to-prime option(s) to complete the priming, as described below.

Hold-to-Prime

The hold-to-prime options allow for precise interactive control of the priming process.

Feed-Only Pump Sets

For Feed-Only Pump Sets, the screen will appear as in Figure 8A. Press and hold ► **HOLD TO PRIME FEED** until the feed line has been primed down to the stepped end connector at the end of the Pump Set.

Feed & Flush Pump Sets

For Feed & Flush Pump Sets, the display will appear as in Figure 8B. First press and hold ► **HOLD TO PRIME FLUSH** to prime the flushing line, and then press and hold ► **HOLD TO PRIME FEED** to prime the feed line down to the stepped end connector at the end of the Pump Set.

If a Feed & Flush Pump Set is used, remember to first press ► **HOLD TO PRIME FLUSH** until the flushing fluid has reached the valve, and then press ► **HOLD TO PRIME FEED** until the feeding fluid has reached past the valve and down to the stepped end connector. If the feeding line is primed first, subsequent priming of the flushing line will force the air between the flush solution bag and valve into the main line, which already has been primed with enteral formula.

Re-priming after Bag Empty

A Pump Set bag that has been emptied will trigger the **FEED ERROR** screen. In this condition the Pump Set bag can be refilled to continue the feeding, but only after the Pump Set has been re-primed.

To re-prime the Pump Set, do the following:

- Disconnect the feeding line from the patient
- Refill the bag
- Press ► **CONTINUE** to begin the pump **RUNNING**
- Press ► **HOLD**
- Press ► **ADJUST SETTINGS**
- Press ► **PRIME PUMP**
- Press ► **HOLD TO PRIME** to prime the line(s)

Pump Sets should not be reused after 24 hours of initial usage.

Selecting Continuous or Intermittent Feed Mode

The KANGAROO ePump enteral feeding pump can be programmed to feed continuously or intermittently.

The continuous feeding mode will deliver the enteral nutrition at a steady rate, either until the programmed volume has been delivered or until the supply has been exhausted. The Intermittent feeding mode delivers boluses of enteral nutrition at programmed time intervals. The bolus volume and feed rate are also programmed.

To select continuous feed mode or intermittent feed mode, press ► **MORE** on the opening menu, shown in Figures 5 or 7, to access the **MORE OPTIONS** menu, Figure 9A.

The **MORE** option is available either before a Pump Set has been loaded (Figure 5) or after the Pump Set is loaded (Figure 7). See subsection "More Options" for information on the other options in the **MORE OPTIONS** menu.

Select ► **CONTINUOUS/INTERMITTENT** under the **MORE OPTIONS** menu, Figure 9A. Then press ► **CONTINUOUS MODE** or ► **INTERMITTENT MODE** from the **SELECT MODE** menu, Figure 9B. Press ► **DONE** to exit.



Figure 9A. **MORE OPTIONS** menu.

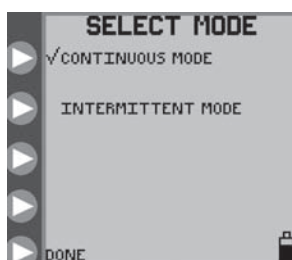


Figure 9B. **SELECT MODE** menu for continuous or intermittent mode selection.

Continuous Mode (Adjust Feed)

Continuous Mode Feeding

For **CONTINUOUS** feeding mode, the **ADJUST FEED** option is available in the opening menus (Figure 7A for Feed-Only sets or Figure 7B for Feed & Flush sets). Select this option to program the feeding parameters from the **ADJUST FEED** screen, Figure 10A.

Press ► **FEED RATE** in Figure 10A to define the rate of delivery. Press the ► buttons in Figure 10B to program the rate from 1 to 400 in increments of 1 ml/hr. Press ► **ENTER** (top button) to exit the menu.

Press ► **FEED VTBD** in Figure 10A to define the Volume To Be Delivered. Press the ► buttons in Figure 10C to program the volume from 1 to 3000 ml in increments of 1 ml. Press ► **ENTER** (top button) to exit the menu. If the **FEED VTBD** is set to zero, the pump will run until the supply is exhausted.

NOTE: When a **FEED VTBD** is set, the remaining volume to be delivered (remaining VTBD) will be displayed next to the icon on the lower right-hand portion of the screen (Figure 10A). If the **FEED VTBD** is reprogrammed during a feeding, from **HOLDING** mode, the pump will restart the feeding and deliver the entire volume of the new VTBD setting.

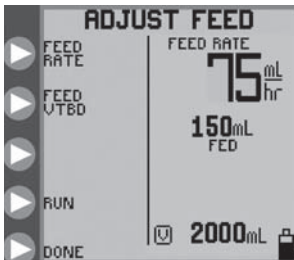
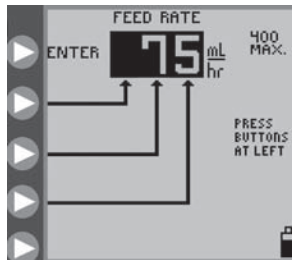
Figure 10A. *ADJUST FEED* menu.

Figure 10B. Setting the Feed Rate.

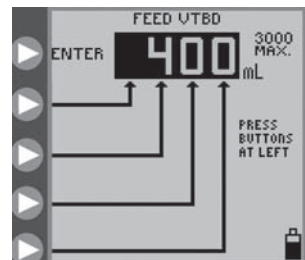


Figure 10C. Setting the Feed Volume to be Delivered.

Continuous Mode Flushing

For **CONTINUOUS** feeding mode with a Feed & Flush Set loaded, the opening menu will appear as shown in Figure 7B. Press ► **ADJUST FLUSH** in Figure 7B to program the flushing parameters from the *ADJUST FLUSH* screen, shown in Figure 11A.

Press ► **FLUSH VOLUME** in Figure 11A to define the volume per flush occurrence. Press the ► buttons in Figure 11B to program the flush volume from 10 to 500 in increments of 1 ml. Press ► **ENTER** (top button) to exit the menu.

Press ► **FLUSH INTERVAL** in Figure 11A to define the time interval between starts of flushing. Press the ► buttons in Figure 11C to program the time interval from 1 to 24 hours in increments of 1 hour. Press ► **ENTER** (top button) to exit the menu.

The pump will automatically limit flushing settings which exceed pump capabilities to deliver.

CAUTION: The KANGAROO ePump enteral feeding pump flushes at a rate of 1960 mL/hr (32.7 mL/minute). Use care when programming the flush volume so that it matches the patient's need.

NOTE: The pump will automatically flush an additional 25 ml of water after completing the programmed delivery of formula, as long as at least one flush had occurred during formula delivery.

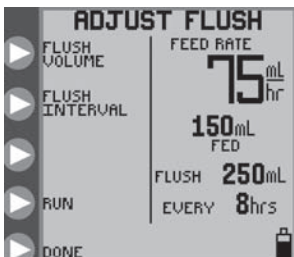
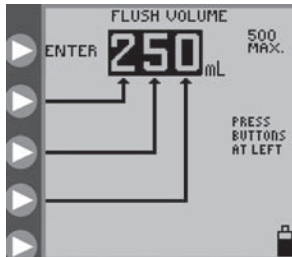
Figure 11A. *ADJUST FLUSH* menu, continuous mode.

Figure 11B. Setting the Flush Volume.

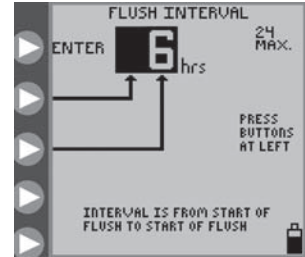


Figure 11C. Setting the Flush Time Interval.

Intermittent Mode (Adjust Bolus)

Intermittent Mode Feeding

For **INTERMITTENT** feeding mode, the **ADJUST BOLUS** option is available in the opening menus (Figure 7C for a Feed-Only set or Figure 7D for a Feed & Flush set). Select this option to program the feeding parameters from the **ADJUST BOLUS** screen, Figure 12A.

Press ► **BOLUS RATE** in Figure 12A to define the rate of delivery.

Press the ► buttons in Figure 12B to program the delivery rate from 1 to 400 in increments of 1 ml/hr.

Press ► **ENTER** (top button) to exit the menu.

Press ► **NUMBER OF BOLUSES** in Figure 12A to define the total number of boluses to be delivered.

Press the ► buttons in Figure 12C to program the number of boluses, up to a maximum of 99.

Press ► **ENTER** (top button) to exit the menu. The number of boluses can be set as zero, in which case the pump will run until the supply is exhausted.

Press ► **VOLUME PER BOLUS** in Figure 12A to define the Volume to be delivered in each bolus.

Press the ► buttons in Figure 12D to program the volume per bolus from 1 to 1000 ml in increments of 1 ml.

Press ► **ENTER** (top button) to exit the menu.

Press ► **BOLUS INTERVAL** in Figure 12A to define the time interval between starts of bolus deliveries.

Press the ► buttons in Figure 12E to program the time interval between starts of bolus deliveries from 1 to 24 hours in increments of 1 hour. Press ► **ENTER** (top button) to exit the menu.

The pump will automatically limit bolus settings which exceed pump capabilities to deliver. For example, a bolus delivery volume of 200 mL cannot be made once per hour if a rate of 150 mL/hr is already programmed. In this case, the maximum volume allowed would be 150 mL.

NOTE: If the **NUMBER OF BOLUSES** is reprogrammed during a feeding (from HOLD mode), the pump will restart the bolus feeding and will deliver all the boluses as defined by the new setting.

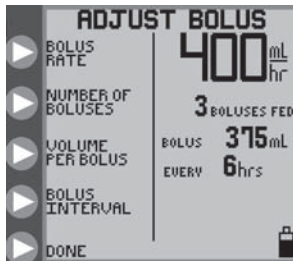
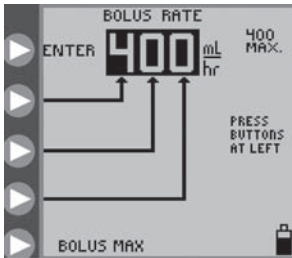
Figure 12A. *ADJUST BOLUS* menu.

Figure 12B. Setting the Bolus Rate.

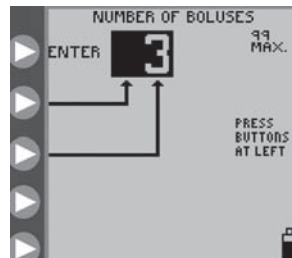


Figure 12C. Setting the Number of Boluses.

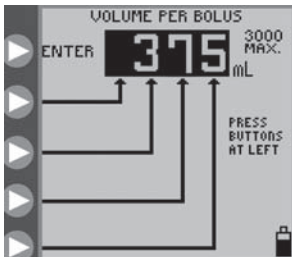


Figure 12D. Setting the volume per Bolus.

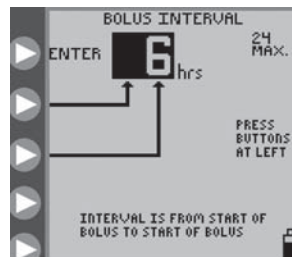


Figure 12E. Setting the time interval between starts of bolus.

Intermittent Mode Feeding – Bolus Max

The **BOLUS MAX** option can be used to deliver a bolus at a high rate, similar to gravity feeding.

Press ► **BOLUS MAX** in the **BOLUS RATE** menu, Figure 12B, to program the **BOLUS MAX** mode.

The feeding rate for **BOLUS MAX** is 999 mL/hr.

Intermittent Mode Flushing

For **INTERMITTENT** feeding mode with a Feed & Flush Set, the opening menu, shown in Figure 7D, will show the **ADJUST FLUSH** option. Press ► **ADJUST FLUSH** in Figure 7D to program the flushing parameters from the **ADJUST FLUSH** screen, Figure 13A.

English

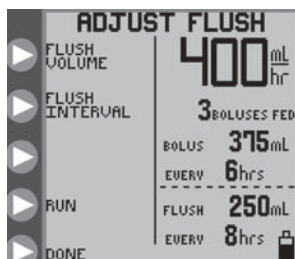


Figure 13A. **ADJUST FLUSH** menu, intermittent mode.

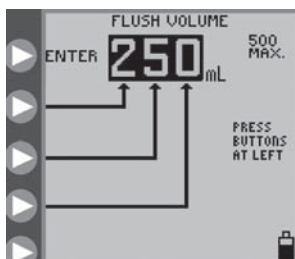


Figure 13B. **Setting the Flush Volume.**

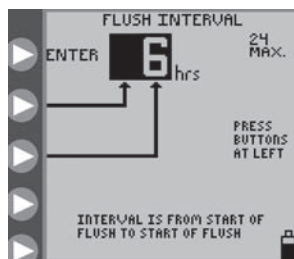


Figure 13C. **Setting the Flush Time Interval.**

Note: The nature of two intermittent processes, periodic bolus feeding and periodic flushing, is such that occasional conflicts can arise where each process needs to be running at the same time. The flushing process is assigned precedence over the feeding process for Feed & Flush pump sets. “Flushing precedence” means that a flush cycle will run to its end even if a bolus delivery is scheduled to begin. It also means that a flush cycle will interrupt a bolus feeding cycle that is already in progress. The feeding cycle will pick up where it was interrupted after the flushing cycle is complete. It is therefore possible that the net feeding volume is reduced from what may be intended, over a given time period.

Press ► **FLUSH VOLUME** in Figure 13A to define the volume per flush cycle. Press the ► buttons in Figure 13B to program the flush volume from 10 to 500 in increments of 1 ml. Press ► **ENTER** (top button) to exit the menu.

Press ► **FLUSH INTERVAL** in Figure 13A to define the time interval between starts of flushing. Press the ► buttons in Figure 13C to program the time interval from 1 to 24 hours in increments of 1 hour. Press ► **ENTER** to exit the menu.

The pump will automatically limit flushing settings which exceed pump capabilities to deliver.

CAUTION: The KANGAROO ePump enteral feeding pump flushes at a rate of 1960 mL/hr (32.7 mL/minute). Use care when programming the flush volume so that it matches the patient’s need.

NOTE: The pump will automatically flush an additional 25 ml of water after completing the programmed delivery of formula, as long as at least one flush had occurred during formula delivery.

Run

The KANGAROO ePump enteral feeding pump will only run when a Pump Set is properly loaded and the necessary feeding parameters have been programmed. For a Feed & Flush Set, the flushing parameters do not have to be set for the pump to begin operating. If flushing parameters are set as zeros, there will be no flushing.

After the pump has been programmed, press ► **RUN** to start operation. Figure 14 shows the **RUNNING** screen for continuous feeding with flushing. The status line will indicate **RUNNING**, and the droplet icon will move vertically on the screen. The green LED indicator will be illuminated to give a quick visual indication of positive status in a darkened room.

The **RUNNING** screen shows the feed rate, amount fed, flushing data if a Feed & Flush Pump Set is used, and the remaining volume to be delivered (remaining VTBD). The remaining VTBD is shown next to the [V] icon.

The **RUN** option can be selected from the following screens, if the proper parameters are programmed and the Pump Set is loaded:

- **SET LOADED** screens (Figure 7)
- **ADJUST FEED** screen, continuous mode (Figure 10A)
- **ADJUST FLUSH** screens (Figure 11A, 13A)
- **HOLDING** screens (Figure 15)

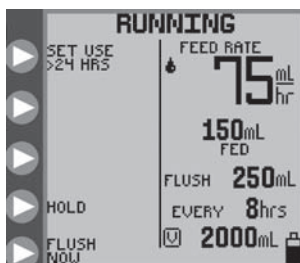


Figure 14. **RUNNING** mode screen for continuous feed mode.

Hold

Pump operation can be paused by pressing ► **HOLD** while it is **RUNNING**, such as in Figure 14. The status line will indicate **HOLDING** and the yellow LED indicator will be lit up to give a quick visual indication of an informational status in a darkened room.

Note: the pump's alarm will sound if it has been left **HOLDING** for 10 minutes without further input. It can be programmed to automatically restart after a specified time period by pressing the ► **RESUME IN ___ MIN.** button.

There are five options available during **HOLDING**. See Figures 15A and 15B.

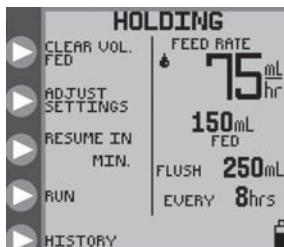


Figure 15A. **HOLDING** mode options, continuous feeding mode.

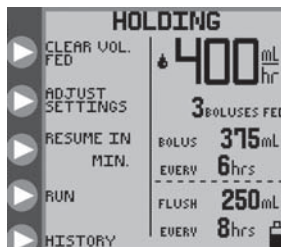


Figure 15B. **HOLDING** mode options, intermittent feeding mode.

English

Clear Volume Fed

Press ► **CLEAR VOLUME** to re-zero the output feed totals “**mL FED**,” “**BOLUSES FED**,” and “**mL FLUSH**.”

Adjust Settings

Press ► **ADJUST SETTINGS** to return to one of the opening menus shown in Figure 7, thus allowing any setting to be modified. If the Pump Set has been removed after going into **HOLD**, the opening menu will show **LOAD A SET**, as seen in Figure 5.

Resume After Specified Time Interval

Press ► **RESUME IN ___ MIN** to immediately input a time in minutes in which to resume operation. Each press of ► **RESUME IN ___ MIN** will increment the resume time by 5-minute increments, up to 30 minutes. After “30” is reached, each additional button press will increment in larger time steps, up to a maximum of 240 minutes. Another button push after 240 will cycle the “resume in” time back to zero. No other input is needed to start the countdown, as the time immediately counts down after the incremental value is reached.

Run Mode

Press ► **RUN** to immediately restart pump operation. This option will not be available if the Pump Set is removed during **HOLD**.

View History

Press ► **HISTORY** to access the **HISTORY** screen. Use this screen to review feeding and flushing history. See subsection “More Options” below for further information.

Flush Now

During the **RUNNING** mode, the pump can be diverted to immediately perform a flush (flush on demand) by pressing ► **FLUSH NOW** in the **RUNNING** menu. See Figure 14. When ► **FLUSH NOW** is pressed, the screen will prompt for the volume to be immediately flushed, and will show the previously programmed flush volume as default. The screen will appear as the standard Flush input screen as shown in Figure 11B (or 13B). Setting the **FLUSH NOW** flushing volume is temporary and will not change the main/periodic flushing volume previously programmed. If ► **FLUSH NOW** is pressed by accident, the screen will return to the **RUNNING** screen after 10 seconds, if there is no input for the flush volume.

More Options

Press ► **MORE** in one of the opening menus, Figures 5 or 7, to access the **MORE OPTIONS** screen, Figure 16.



Figure 16. **MORE OPTIONS** menu.

Buzzer Alarm Volume

Press ► **BUZZER** in the **MORE OPTIONS** menu to access the **BUZZER** screen and increase or decrease the alarm buzzer volume. The alarm will be audible as the volume setting is changed. This sets the volume level for any warning or error that may occur with the pump. Critical errors of **SYSTEM ERROR** and **PUMP SET DISLODGED** will always use the maximum volume setting.

History

Press ► **HISTORY** in the **MORE OPTIONS** menu to access the **HISTORY** screen. Press the ► buttons in Figure 17 to set the time history of interest. The totals of **FEED mL** and **FLUSH mL** will be shown for the requested history time.

WARNING: A maximum of 72 hours of past history can be retrieved, excluding data from the current hour.

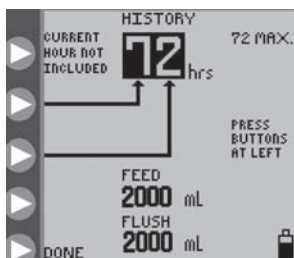


Figure 17. Feed and Flush totals for up to 72 hours of previous history, excluding data from the current hour.

Language Selection

Press ► **LANGUAGES** in the **MORE OPTIONS** menu to change the preferred language for the screen interface.

Continuous/Intermittent Mode

Press ► **CONTINUOUS/INTERMITTENT** in the **MORE OPTIONS** menu to access the **SELECT MODE** menu, Figure 9B. Use this menu to select between continuous feeding mode and intermittent feeding mode. See subsection “Selecting Continuous or Intermittent Feed Mode” for more information.

Press ► **DONE** in the **MORE OPTIONS** menu to exit the menu.

BioTech Menu

The BioTech screen will show technical information about the pump, and has a lock feature to lock the Pump Settings against unauthorized changes.

Accessing the BioTech Screen

To get the BioTech screen, press the power button to start the pump, and press and hold the top ► button while the startup sequence (Kangaroo icon “hops” across the screen) executes. You must be pressing the top ► button at the end of the sequence in order to access the BioTech menu. Figure 18 shows the BioTech screen.

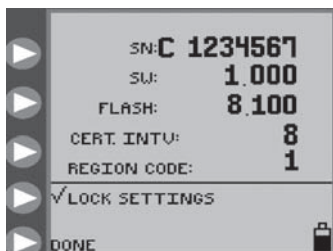


Figure 18. BioTech screen, with Pump Settings “locked” against unauthorized changes.

BioTech Screen Data

SN is the serial number of the pump.

SW shows the software version number in this pump.

FLASH shows the version number of the flash data installed in this pump.

CERT INTV indicates the number of times the pump has been powered on since the last re-certification. See Section VI for details of re-certifying the pump.

Lock Settings Feature (Program Locked)

To “lock” the settings against unauthorized changes, press ► **LOCK SETTINGS** to get the check mark, as shown in Figure 18. The settings can only be changed again by pressing ► **LOCK SETTINGS** to remove the check mark. If the settings are locked and a change is attempted, the screen will indicate **PROGRAM LOCKED**, and will not allow access to the parameters, Figure 19.

The pump can be **PRIMED** or set to **RUN, HOLD**, etc. when settings are locked.

Press ► **DONE** to exit the BioTech menu. To re-enter this menu screen, power down the pump and then power it up again and hold the top ► button, as described above.



Figure 19. Program Locked screen, which indicates the pump is in LOCK SETTINGS mode.

Lock Screen Feature

The KANGAROO ePump enteral feeding pump can be set to **RUN** and then locked out from unauthorized use. While the **LOCK SETTINGS** feature prevents only changes to the input parameters, the **LOCK SCREEN** feature will lock out any button presses, including **RUN** or **HOLD**, except power off.

Use **LOCK SCREEN** when the pump is running and there is a need to prevent tampering such as putting the pump into an unwanted **HOLD**. The **RUNNING** screen will show a padlock to indicate that no changes can be made without unlocking the screen.

To lock the screen, use the following procedure while the pump is in **RUNNING** mode:

- Press and hold the second ► button from the top for at least 2 seconds, and then release it.
- Press and hold the third ► button from the top for at least 2 seconds, and then release it.
- Press and hold the second ► button again for at least 2 seconds.

To unlock the screen, use the same procedure above.

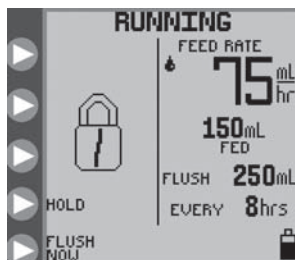


Figure 20. Padlock indicates pump is in LOCK SCREEN mode.

Section VI – Re-Certification of Performance

System Performance Re-Certification

A series of self-diagnostic checks can be run to re-certify pump performance. It is recommended that this re-certification procedure be run at least once per year, or any time the pump is suspected of having improper performance. See Section XIII-Service Part Numbers for ordering new Re-Certification Pump Sets.

English

Load the Re-Certification Pump Set. The pump will automatically recognize the Re-Certification Pump Set and give brief instructions to initiate the self-diagnostic procedure. Follow the instructions and review the pass/fail information at the end of the test.

Certifying the Accuracy of Pump Flow Rate

Use the following procedure to check the flow rate accuracy:

- Perform test at room temperature $22^{\circ}\text{C} \pm 2^{\circ}\text{C}$ ($72^{\circ}\text{F} \pm 3^{\circ}\text{F}$) with a new Pump Set.
- Fully fill a new Feed-Only Pump set bag with water.
- Load the Pump Set.
- Suspend the Pump Set bag so that the bottom of the bag is 18 inches above the pump.
- Make sure pump is plugged into A/C power (do not run test with battery power).
- Program a Continuous Mode feed rate (see below for suggested example rates).
- Run the pump for 15 minutes to achieve steady state operation.
- Then begin collecting the water in a calibrated measuring container, such as a large-capacity graduated cylinder, for exactly 30 minutes.

NOTE: The amount of water collected in 30 minutes will be half of the value programmed for the hourly flow rate, within $\pm 10\%$, or 0.5 mL, whichever is larger.

<i>Rate Set</i>	<i>Amount Expected in 30 Minutes</i>
75 mL/hr	33.7 mL to 41.3 mL
150 mL/hr	67.5 mL to 82.5 mL

If the amount collected is outside the range, load a new Pump Set and re-run the test procedure to confirm results.

Section VII — Cleaning

Cleaning should be performed as needed. It may also be desirable to define cleaning intervals based on knowledge of the environment in which the pump is used. Only personnel trained in the cleaning of medical devices should perform cleaning.

CAUTION: Do not immerse pump or power cord in water or other cleaning solution; clean using a damp (not wet) cloth or sponge. Failure to follow the cleaning procedures described herein could result in hazards to users. As with any AC powered electrical device, care must be taken to prevent liquid from entering the pump to avoid electrical shock hazard, fire hazard, or damage to electrical components.

If any of the following events occur, DO NOT USE the pump until it has been properly cleaned and serviced by personnel trained in servicing KANGAROO ePump enteral feeding pumps:

- wetting of the pump's power cord or leakage into the pump interior during cleaning.
- spillage of large amounts of formula onto the pump exterior, or any spillage onto the power cord.

General Cleaning Directions

Cleaning of KANGAROO ePump enteral feeding pumps must be performed as follows:

CAUTION: Disconnect pump from AC power source before cleaning. After cleaning, do not connect to AC power source until pump and power cord are thoroughly dry.

- A mild detergent should be used for general cleaning. If necessary, the pump may be cleaned with a 10:1 water and hypochlorite mixture, however, repeated cleaning with this solution can damage the plastic pump case. Isopropyl alcohol, applied with a damp (not wet) cotton swab, may be used for cleaning difficult-to-reach areas, however, it should be used sparingly because repeated cleaning may damage the case.
- DO NOT USE strong cleaners such as Spray-Nine™, PhisoHex™, Hibiclens™, or Vesta-Syde™ because damage to the pump case housing can result.

Directions for Cleaning Pump Housing

- Refer to General Cleaning Directions before starting.
- Clean outside surface with a damp (not wet) cloth or sponge and keep pump in upright position as much as possible.
- Avoid excess moisture near pole clamp area.
- Do not allow cleaning solution to enter the vertical vents in the housing, underneath the handle.

Directions for Cleaning Pump Power Cord

- Refer to General Cleaning Directions before starting.
- Unless soiling is observed, the power cord should not be cleaned.
- If cleaning of the power cord is necessary, unplug from outlet and wipe the exterior surfaces of the wall plug with a cloth dampened with isopropyl alcohol.

CAUTION: Avoid exposing power cord to excess moisture, as this can lead to an electrical shock or fire hazard.

Directions for Cleaning Rotor Assembly

- Refer to General Cleaning Directions before starting.
- Open the blue door enclosing the Pump Set loading area.
- Loosen rotor set screw with 5/64" (2mm) allen wrench and gently pull rotor off shaft. After removing rotor, avoid getting any moisture in the rotor shaft opening.
- Clean rollers thoroughly with warm soapy water, or isopropyl alcohol if necessary.
- Be sure all parts of rotor are completely dry before putting it back onto shaft.
- To replace rotor, align set screw on hub of rotor with the flattened section of the output shaft.
- Push rotor into place and tighten set screw (Do not over tighten).

English

Preventative Maintenance

This pump must be periodically re-certified to assure proper functioning and safety. The recommended service interval is at least once per year. Re-certification may be done at the user's Biomedical Engineering Department, an outside service, or by Tyco Healthcare Group LP Factory Service. To arrange for Tyco Healthcare Group LP Factory Service, call 1-800-448-0190. In Canada, call 1-877-664-TYCO(8926)

If a pump malfunctions, please contact your THGLP Representative or call Customer Service for instruction.

Section VIII — Battery Replacement

See Figure 21 and do the following to replace the Battery Pack:

- Power down the unit.
- Loosen the Battery Door screw, on back of pump.
- Open Battery Door and disconnect wire harness. A small straight-bladed screw driver may be needed to disconnect the connector tab.
- Slide Battery Pack out of compartment.
- Slide a new Battery Pack into compartment with wire harness extending out.
- Align connector with red wire at upper right.
- Push connector in until properly latched.
- Tuck wires into slot between connector and battery to insure wires are not pinched. Re-tighten Battery Door screw.

Note: Replacement Battery Packs are available from Tyco Healthcare/Kendall Co. (See Section XIII – Service Part Numbers).

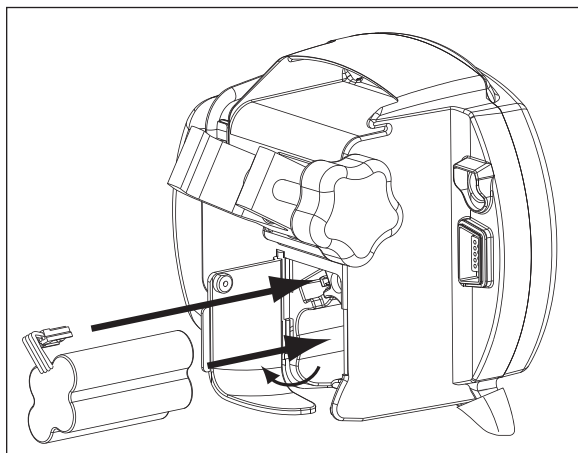


Figure 21. Installation of Battery Pack.

WARNING: USE OF A BATTERY PACK NOT SUPPLIED BY TYCO HEALTHCARE/KENDALL CAN BE DANGEROUS AND VOIDS ALL WARRANTIES AND PERFORMANCE SPECIFICATIONS.

The battery will charge continuously whenever the pump is plugged into a wall outlet. Eight hours of charging is required to fully recharge the Battery Pack.

Section IX — Error/Warning/Informational Screens and Troubleshooting

For operational errors, the KANGAROO ePump enteral feeding pump display will show the error indicator icon, with specific information regarding the error condition, and will sound the alarm.

The following conditions will trigger error conditions and will activate audible and visible alarms:

- Feed or Flush containers are empty
- Feed or Flush tube becomes occluded between bag and pump
- Tube becomes occluded between pump and patient
- Battery low (alarm beeps continuously, about 15 minutes before shut-off)
- Unit is left in HOLD mode longer than 10 minutes without input
- Pump Set tubing is improperly loaded around the rotor
- System errors, see below
- Feeding complete
- The MISTIC connector is removed during **AUTOPRIMING** or **RUNNING**

The Error, Warning, and Information Screens are described below:

System Error

The system error screen is the most general form of error, Figure 22. The only way to exit from a System Error is to power down. No **CONTINUE** option is allowed because of the severity of the error. An error number is also displayed on the screen, for reference purposes. This number should be reported when calling the Customer Service Support Line.

Error # Related Sub-system

- | | |
|----|--|
| 0 | Internal timer stopped. |
| 1 | Flash Chip missing OR version incompatible. |
| 2 | Too many graphic screens in memory. |
| 4 | Never got a ADC ISR for motor current. |
| 5 | Never got a ADC ISR for battery level. |
| 6 | Never got a ADC ISR for battery temperature. |
| 7 | Never got a ADC ISR for Ultrasonic Upstream Occlusion or Bag-Empty checks. |
| 8 | Never got a ADC ISR for Ultrasonic during Downstream Occlusion. |
| 9 | RS232 Communications Transmit. |
| 10 | Flash Write Error. |
| 11 | Flash Read Error. |
| 12 | Stopcock Time Out. |
| 13 | Time Out for Buzzer Test |

English

Error # Related Sub-system

- 14 Time Out during downstream occlusion check, never got RotorOn3=0. May blow fuse.
- 20 Could not find Stop Cock Flush Position during prime routine.
- 21 Could not find Stop Cock Feed Position during prime routine.
- 22 Motor Error during Tubing AutoLoad.
- 23 Motor Failsafe Time Out Error. Possible damaged gearbox encoder or flex cable.
- 33 Motor Control Failure.
- 50 Graphic Display Error - Timeout during GDStatusCheck function.
- 51 Graphic Display Error - Timeout during GDAutoModeDataWriteCheck function.
- 52 Graphic Display Error - Timeout during GDWriteBytes function.

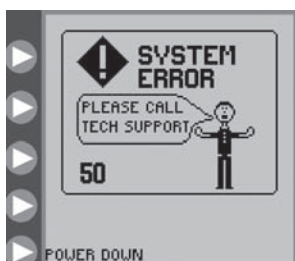


Figure 22. General System Error screen. See Customer Service section.

Turn the power off and back on to try to clear the error. If the error cannot be resolved in a timely manner, press **POWER** to stop operation of the pump and put a different pump into service.

Hold Error

The **HOLD ERROR** screen will appear if the pump has been inactive, without input, for more than 10 minutes. See subsection "Hold" for description of **HOLDING** mode.

Press **▶ CONTINUE** to return to the previous screen. Where settings can be adjusted, the pump can be set to run immediately, or the pump can be set to run in a specified number of minutes. See Figure 15 to see the options on the **HOLDING** menu screen.

If the error cannot be resolved, press **POWER** to stop operation of the pump and put a different pump into service.

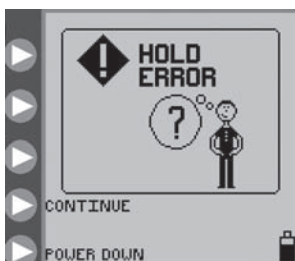


Figure 23. Hold Error screen.

Rotor Error

The **ROTOR ERROR** screen appears during **RUNNING** or **PRIMING**, when the pump has detected an unusual operating condition for the rotor. See Figure 24. The **ROTOR ERROR** generally results from a problem with the Pump Set tubing around the rotor.

Check that the Pump Set is not damaged, and re-load the tubing around the rotor as described in subsection "Loading Pump Sets". Press ► **CONTINUE** to restart.

If the error cannot be resolved, press  **POWER** to stop operation of the pump and put a different pump into service.

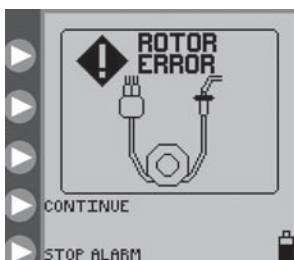


Figure 24. Rotor Error screen.
Re-load the set tubing and press **CONTINUE**.

Feed Error

The **FEED ERROR** screen appears when the enteral formula is no longer being delivered because the bag is empty or because of a clog between the pump and the bag. Check the feed line to find the occlusion causing the blockage. If the occlusion cannot be cleared, load a new Pump Set, prime it, and restart the feeding.

If the error still cannot be resolved, press  **POWER** to stop operation of the pump and put a different pump into service.



Figure 25. Feed Error screen.

Flush Error

The **FLUSH ERROR** screen appears when the flushing solution is no longer being delivered because the flush bag is empty or because of a clog between the pump and flush bag. Check the flush line to find the occlusion causing the blockage. If the occlusion cannot be cleared, load a new Pump Set, prime it, and restart the feeding.

English

If the error still cannot be resolved, press **POWER** to stop operation of the pump and put a different pump into service.



Figure 26. Flush Error screen.

Flow Error

The **FLOW ERROR** screen appears when either the feeding or the flushing solution is no longer being delivered because of a clog between the pump and the patient. Check the line to find the occlusion causing the blockage. If the error cannot be resolved, check the valve pocket in the Pump Set loading area for dampness or dirt, which may be a cause for a false error. Clean and dry the valve pocket. If the error still cannot be resolved, load a new Pump Set, prime it, and restart the feeding.

If the error still cannot be resolved, press **POWER** to stop operation of the pump and put a different pump into service.

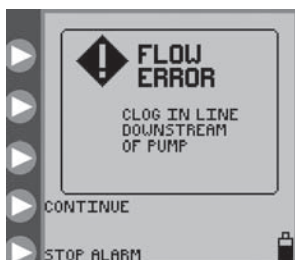


Figure 27. Flow Error screen.

Pump Set Dislodged Error

The **PUMP SET DISLODGED** screen will appear if the black ring retainer (MISTIC) is not properly loaded in the MISTIC pocket in the Pump Set loading area. Check and correct the positioning of the MISTIC retainer if possible. If the error cannot be resolved, load a new Pump Set, prime it, and restart the feeding.

If the error cannot be resolved, press **POWER** to stop operation of the pump and put a different pump into service.

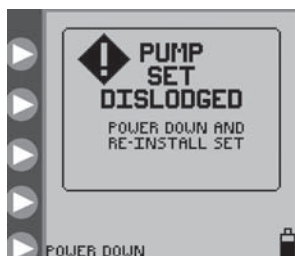


Figure 28. Pump Set Dislodged Error screen.

Battery Low

The **BATTERY LOW** screen appears and the alarm beeps continuously when the battery needs to be recharged. There is approximately 15 minutes of battery life remaining when this screen appears.

Plug the power cord in to begin recharging. The pump will automatically return to the screen that was active prior to the error. The battery will charge continuously whenever the pump is plugged into a wall outlet. Eight hours of charging is required to fully recharge the battery pack.

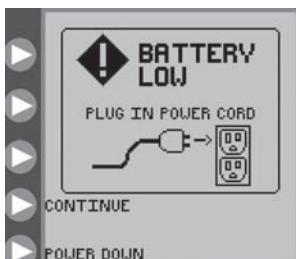


Figure 29. Battery Low error screen. Indicates that the battery must be recharged immediately.

Feeding Complete

The **FEEDING COMPLETE** information screen appears after completion of the programmed feeding. Press ► **POWER DOWN** to turn off the pump. Press ► **CONTINUE** to return to the **SET LOADED** opening menu, Figure 7.



Figure 30. Feeding Complete notification screen.

Pump Set Use >24 Hours Warning

The Pump Set usage warning indicator will blink on the **RUNNING** screen if a Pump Set has been used for 24 or more hours. It is recommended to replace Pump Sets after this length of usage. This icon is only an informational message and does not require action.

Figure 31 shows an example of the **RUNNING** screen, where a Feed & Flush Set has been in use for more than 24 hours. The informational warning indicator shows up in the upper left on the screen.

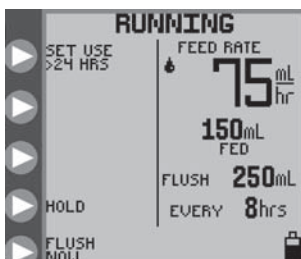


Figure 31. Running screen with the > 24 HRS of Pump Set Usage indicator in upper left of the screen.

LED Array

The pump status LED array on the upper right of the pump gives a quick visual indication of the pump status, especially in darkened rooms.

A green light status indicates normal pump operation.

A yellow light status indicates an informational or warning situation for a low battery condition, the pump in **HOLDING** mode, or one of the following errors: **HOLD ERROR**, **FEED ERROR**, **FLOW ERROR**, and **FLUSH ERROR**.

A red light status indicates a critical pump error. The screen will show one of the following error messages: **SYSTEM ERROR**, **PUMP SET DISLODGED**, or **ROTOR ERROR**.

Section X — Specifications and Symbols

Specifications

UL Listing



Medical Electrical Equipment

KANGAROO ePump™ Enteral Feeding Pump

(1) Classified with respect to electrical shock, fire, and mechanical hazards in accordance with UL60601-1.

(2) Classified with respect to electrical shock, fire, mechanical and other specified hazards in accordance with CAN/CSA C22.2 No. 601.1

Type Infusion Device

Volumetric

Pumping Mechanism

Rotary Peristaltic

Pump Sets

KANGAROO ePump MISTIC Feed-Only Set or Feed & Flush Set

Feeding Formula Delivery Rate

1-400 ml/hr in 1 ml increments

Feeding Formula VTBD

1-3000 ml in 1 ml increments

Bolus Volume

1-1000 ml in 1 ml increments

Number of Boluses

1-99

Bolus Interval

1-24 hours in 1-hour increments

Flushing Solution Dose Range

10–500 ml in 1 ml increments

Flushing Solution Interval Range

1–24 hr in 1 hr increments

Accuracy

±10% or 0.5 ml/hr, whichever is larger, with bag at 46 cm (18") above pump, at room temperature $22^{\circ}\text{C} \pm 2^{\circ}\text{C}$ ($72^{\circ}\text{F} \pm 3^{\circ}\text{F}$), using a new pump set with less than the recommended 24 hours of maximum usage.

Occlusion Pressure

15 psi (103 kPa) Maximum

Dimensions

Height: 16.8 cm (6.6") Width: 16.3 cm (6.4") Depth: 11.7 cm (4.6")

Weight

1.1 kg (2.4 lbs), 1.2 kg (2.7 lbs) with pole clamp

Material

Housing: ABS/Polycarbonate blend

Pump Set Door: Polyester/ Polycarbonate blend

Power

Use AC adapter for wall outlet usage. Pump operates on 9V DC, 1.5 Amps.

Battery

New, fully charged NiMH Battery Pack delivers ≥ 15 hrs at 100 ml/hr feed rate. Approximately 15 minutes prior to complete battery discharge, a low battery alarm will occur (see subsection "Battery Low" in Section IX). When complete discharge occurs, the pump will automatically turn itself off.

The battery will charge continuously whenever the pump is plugged into a wall outlet. Eight hours of charging is required to fully recharge the battery pack.

Alarms

- System Error
- Flow Error
- Pump Set Dislodged Error
- Hold Error
- Rotor Error
- Feed Error
- Flush Error
- Battery Low

Alarm Volume

Minimum of 70 dBA at 1 meter in maximum volume orientation

English

Operating Temperature

10° - 40° C (50° - 104° F) 75% R.H. non-condensing

Storage Temperature

0° - 50° C (32° - 122° F) 95% R.H. non-condensing

Type of Protection Against Electrical Shock

Class II, Internally-powered Equipment

Degree of Protection Against Electrical Shock

Type BF

Mode of Operation

Continuous or programmed intermittent operation

Degree of Protection Against Ingress of Fluids

Drip-proof-IPX1

Symbols on Pump and Accessories

The following symbols are found on the pump or on the accessories, such as the A/C adapter.



Refer to Accompanying Documents

See Instructions



Type BF Protection (Degree of protection against electrical shock - there is no conductive connection to the patient)



Manufacturing Date Code

SN

Serial Number

REF

Reorder number for the device located on the carton label



Alternating Current



Class II Equipment (degree of protection against electrical shock), Double Insulated



Direct Current (DC)

IPX1

Drip Proof (Degree of protection against ingress of fluids)



0123

CE Mark – European Community Certification



Power Button



Buttons for Selecting Screen Prompts



Power Source
9V DC 1.5 Amp



DB9 Serial I/O
Communication Port
(Certification and Programming)



VDE in Europe



UL in USA
and Canada



Japanese
Certification



Caution: For indoor use only



Functional Ground



Do not use Kangaroo ePump
Feeding Sets for greater than
24 hours



Do not use if unit package is
open or damaged



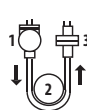
Flushing Solution



Feeding Formula



See Kangaroo ePump
Manual for Feeding Set
loading instructions



1. Grasp finger tab on valve and insert into left pocket
2. Grasp black ring retainer and gently stretch tubing around rotor
3. Pull up on retainer and insert into right pocket



Maximum
operating pressure
103 kPa



Assure that the
white cap and red
stepped connector
are securely
tightened

Section XI — Customer Service

The circuitry of the KANGAROO ePump enteral feeding pump is not customer serviceable. In particular, electronic assembly rework by non-authorized KANGAROO ePump enteral feeding pump technicians will likely affect accuracy. Certain replacement items, as listed in Section XIII - Service Part Numbers, are available from the service centers listed below.

All service personnel must be properly trained and qualified with operation of the KANGAROO ePump enteral feeding pump. Improper service may impair operation of the pump.

Return for Repair

1. Call Customer Service for an Authorized Return Number and shipping instructions, using the appropriate phone number below:
2. Pack the instrument carefully and ship the insured parcel to:

United States

Tyco Healthcare Group LP
98.6 Faichney Drive
Watertown, NY 13601
1-800-448-0190 or (315) 788-5246

Canada

Tyco Healthcare Canada
7300 Trans-Canada
Pointe-Claire, Québec, Canada, H9R 1C7
1-877-664-8926 or (514) 698-1220

U.K. Service Center (*Outside of U.S. and Canada*)

Tyco Healthcare Group LP
20 Garryduff Road
Ballymoney, BT53 7AP
+44-28276-61719

Section XII — Maintenance

For general maintenance issues not discussed below, contact Customer Service (Section XI).

WARNING: Do not open the main housing, as there are no user-serviceable parts inside. Opening of device may affect function of device and voids the warranty.

The following maintenance items/parts can be replaced by the customer on the KANGAROO ePump enteral feeding pump. See Section XIII for Service Part Numbers and Section XI for contacting Customer Service.

Side Door enclosing Pump Set Loading area

To replace the Side Door, see Figure 32 and do the following:

1. Place top Door Hinge onto the Top Hinge Pin.
2. Carefully press down on the bottom of the door to spread the door hinges apart.
3. Place the bottom Door Hinge onto the Bottom Hinge Pin.

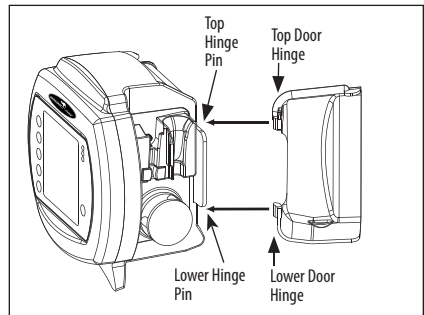


Figure 32. Blue Door Replacement.

English

Battery Pack

See Section VIII for full instructions on replacing Battery Pack. During long-term non-usage or storage (greater than 9 months) of the pump, battery discharge and deactivation may tend to occur. It is recommended that the battery be disconnected during this time. The battery may need to be charged and discharged several times to restore optimal capacity.

Battery Door

To replace Battery Door, see Figure 33 and do the following:

1. Align the Battery Door Hinges with the long hinge pins.
2. Snap the hinges onto the hinge pins.
3. Screw down the door to hold in place.

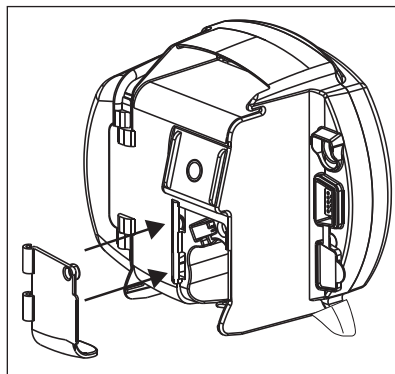


Figure 33. Battery Door Replacement.

Power Cord

See Section IV for initial setup, including Power Cord attachment.

Pole Clamp

See Section IV for initial setup, including attachment of the Pole Clamp to the pump.

Section XIII – Service Part Numbers

To place an order for parts, or if technical assistance is required, call customer service.

The KANGAROO ePump enteral feeding pump contains a limited number of serviceable parts. User maintenance is to be performed only by appropriately qualified technical personnel.

Visit our web site at: www.TycoHealthcare.com

- | | |
|---------------------------------------|------------------------------|
| (1) KANGAROO ePump | (US) 382400 |
| | (International) 482400 |
| (2) Main Door (Blue transparent door) | F31877WT |
| (3) Battery Pack | F010484WT |
| (4) Battery Door (with Screw) | F31878WT |
| Power Cord (with A/C Adapter) | 382491 |
| (5) Pole Clamp | 382492 |
| Electrical Plugs (Set of 4) | 382493 |
| Re-Certification Pump Set | 776150 |

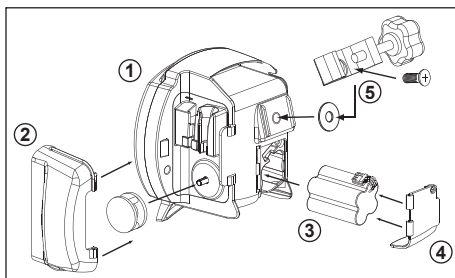


Figure 34. User Serviceable Parts.

Section XIV – Warranty

LIMITED WARRANTY: Kendall, a Tyco Healthcare Group LP company, warrants to the original purchaser (“Customer”) that this product will be free of defects in materials and workmanship, under normal use, for one (1) year from the date of original purchase from Kendall or its authorized distributor. If this product does not operate as warranted above during the applicable warranty period, Kendall may, at its option and expense, replace the defective part or product with a comparable part or product, repair the defective part or product, or, if neither replacement nor repair is reasonably available, refund to Customer the purchase price for the defective part or product. Dated proof of original purchase will be required. Kendall does not assume any liability for loss arising from unauthorized repair, misuse, neglect, or accident. Removal, defacement, or alteration of serial lot number voids warranty. Kendall disclaims all other warranties, expressed or implied, including any implied warranty of merchantability or fitness for a particular purpose or application other than as expressly set forth in the product labeling.

Section XV – Electromagnetic Conformity Declaration

The KANGAROO ePump enteral feeding pump has been built and tested according to UL60601-1, E181931 CSA-C22.2 No.601.1-M90, and EN60601-1-2 Standards.

The KANGAROO ePump enteral feeding pump is intended for use in the electromagnetic environment specified below. The user of the pump should assure that it is used in such an environment.

Emissions Test	Compliance	Electromagnetic Environment - Guidance
RF emissions (CISPR 11)	Group 1	The KANGAROO ePump uses RF energy only for its internal function. Therefore, its RF emissions are very low and are not likely to cause any interference in nearby electronic equipment.
RF emissions (CISPR 11)	Class B	The KANGAROO ePump is suitable for use in all establishments, including domestic establishments and those directly connected to the public low-voltage power supply network that supplies buildings used for domestic purposes.
Harmonic emissions (IEC 61000-3-2)	Class A	
Voltage fluctuations/ flicker emissions (IEC 61000-3-3)	Complies	
Radiated Disturbance Immunity (EN60601-1-2 / IEC 61000-4-3:2002)	Complies	
Conducted Disturbance Immunity (EN60601-1-2 / IEC 61000-4-6:2001)	Complies	
Power Frequency Magnetic Field Immunity (EN60601-1-2 / IEC 61000-4-8:2001)	Complies	
Voltage dips and sags Immunity (EN60601-1-2 / IEC 61000-4-11:2001)	Complies	
Electrical Fast Transient / Bursts Immunity (EN60601-1-2 / IEC 61000-4-4:2001)	Complies	
Electrostatic Discharge Immunity (EN60601-1-2 / IEC 61000-4-2:2001)	Complies	
Surge Immunity (EN60601-1-2 / IEC 61000-4-5:2001)	Complies	

Section XVI – AccuSystem√

The KANGAROO ePump is a reliable and accurate enteral feeding device. The reason for the accuracy of the KANGAROO ePump enteral feeding pump is the design, controlled calibration methods, and stringent manufacturing controls. One of the most critical functional parts of the KANGAROO ePump enteral feeding platform is the AccuSystem√ feeding set produced by Tyco Healthcare. The functionality of the KANGAROO ePump AccuSystem√ feeding set is extremely important for maintaining quality and also for allowing the accurate delivery of nutrition and hydration.

The reason the KANGAROO ePump enteral feeding pump and the KANGAROO ePump AccuSystem√ feeding sets have satisfied our customers' expectations is due to the integration of these two parts during the manufacturing process. The KANGAROO ePump AccuSystem√ feeding set manufacturing process parameters are tightly controlled at Tyco Healthcare to minimize variation and produce consistent and reliable products. The special grades of thermoplastic materials are also tightly controlled, and are specifically chosen to deliver consistent quality and accurate flow delivery with the KANGAROO ePump enteral feeding pump. The factory calibration and final determination of an acceptable KANGAROO ePump enteral feeding pump is dependent on the use of acceptable Tyco Healthcare KANGAROO ePump AccuSystem√ feeding sets. The use of generic feeding sets or other feeding sets not produced by Tyco Healthcare is not supported or sanctioned by Tyco Healthcare. The use of unauthorized KANGAROO ePump feeding sets could jeopardize the accuracy of the KANGAROO ePump enteral feeding pump. Check your feeding set for the AccuSystem√ logo to be certain that your KANGAROO ePump enteral feeding pump will deliver accurately every time it is utilized.



OXYGEN CALL LIST

Monday Tuesday Wednesday Thursday Friday

Automatic Stop Call Weekly Every 2 Weekly Call 6 months Call Annually

(except MCR 3-5 yr customers, identify who called in the order and how much they have left)

Note:

1. Customers must be aware of their delivery day. They should call before noon on the business before their delivery day. We should not have "will call us" customers! After the first month, homefill **and** night time customers **with** internal filter concentrators will be called and have a home PMI at least every 6 months. Night time customers **without internal filters** must have a home PMI annually.
2. When making oxygen calls, if a customer only has 1-2 empty tanks, see if they have enough full tanks to last them another week.
3. Check on all **repeat supplies** with every 6 month / annual check. I.e. neb kits and filters, cpap / bipap supplies, etc
4. **Confirm** address, insurance and physician information with every supply order.

Name: _____ Phone: _____

(always make calls while looking at and updating the customers information in the computer)

(circle) **OXL OXQ OXM OXE OXD OXC OXB**

(circle) Home-Fill Cylinder: **Continuous Conserver** or **Helios** or **Conserver**

Comments/Supplies: _____

Other Equipment: _____

(circle) Rental Air Compressor with internal filter or **Rental Enteral Pump**

Annual check due _____ Form ADFM024 initiated ____/____/____ By: _____ PMI Completed date ____/____/____

Annual check due _____ Form ADFM024 initiated ____/____/____ By: _____ PMI Completed date ____/____/____

(use form ADFM024 for all oxygen set ups, all rental swaps, and rental equipment checks)

Concentrator Set up date _____ internal filter = every 6 months / no internal filter = annually

Physicians order: LPM _____ Duration _____ (check most current prescription / CMN on on-base, see DTWI004.)

PMI check due _____ Form ADFM024 initiated ____/____/____ By: _____ PMI Completed date ____/____/____

PMI check due _____ Form ADFM024 initiated ____/____/____ By: _____ PMI Completed date ____/____/____

PMI check due _____ Form ADFM024 initiated ____/____/____ By: _____ PMI Completed date ____/____/____

PMI check due _____ Form ADFM024 initiated ____/____/____ By: _____ PMI Completed date ____/____/____

PMI check due _____ Form ADFM024 initiated ____/____/____ By: _____ PMI Completed date ____/____/____

PMI check due _____ Form ADFM024 initiated ____/____/____ By: _____ PMI Completed date ____/____/____

Account #: _____

